

HORIZONTAL STABILIZER 3/32 BALS

ELEVATOR 3/32 BALS

FUSELAGE 1/4" BALS

GUSSETS 1/4" BALS

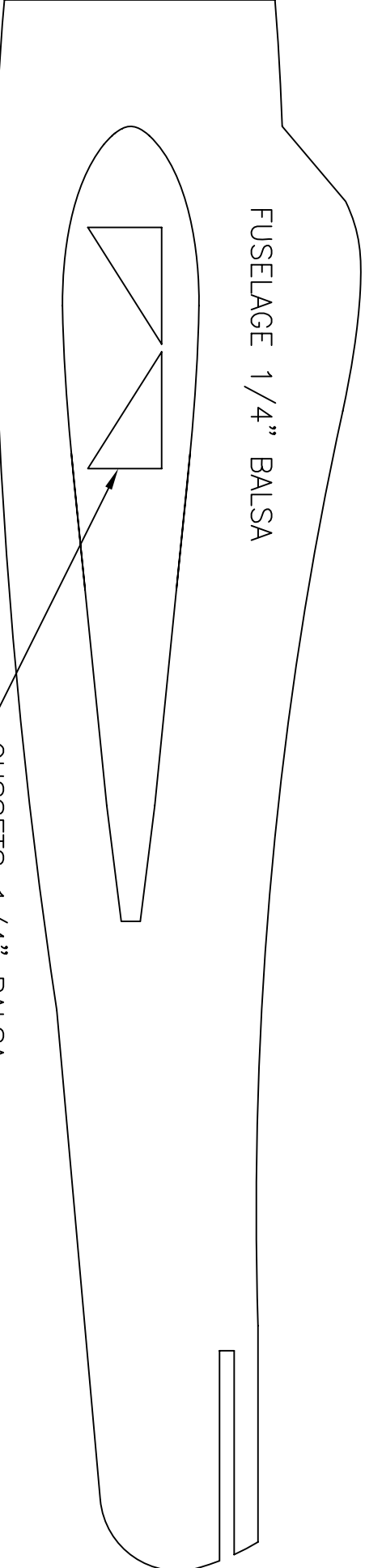
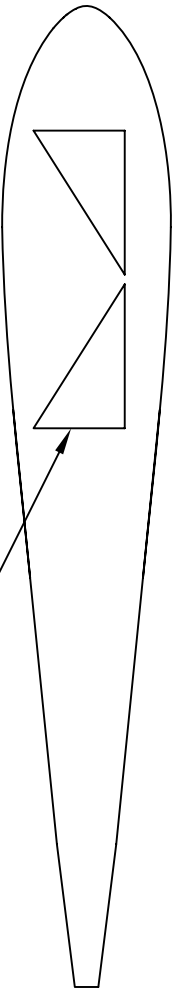

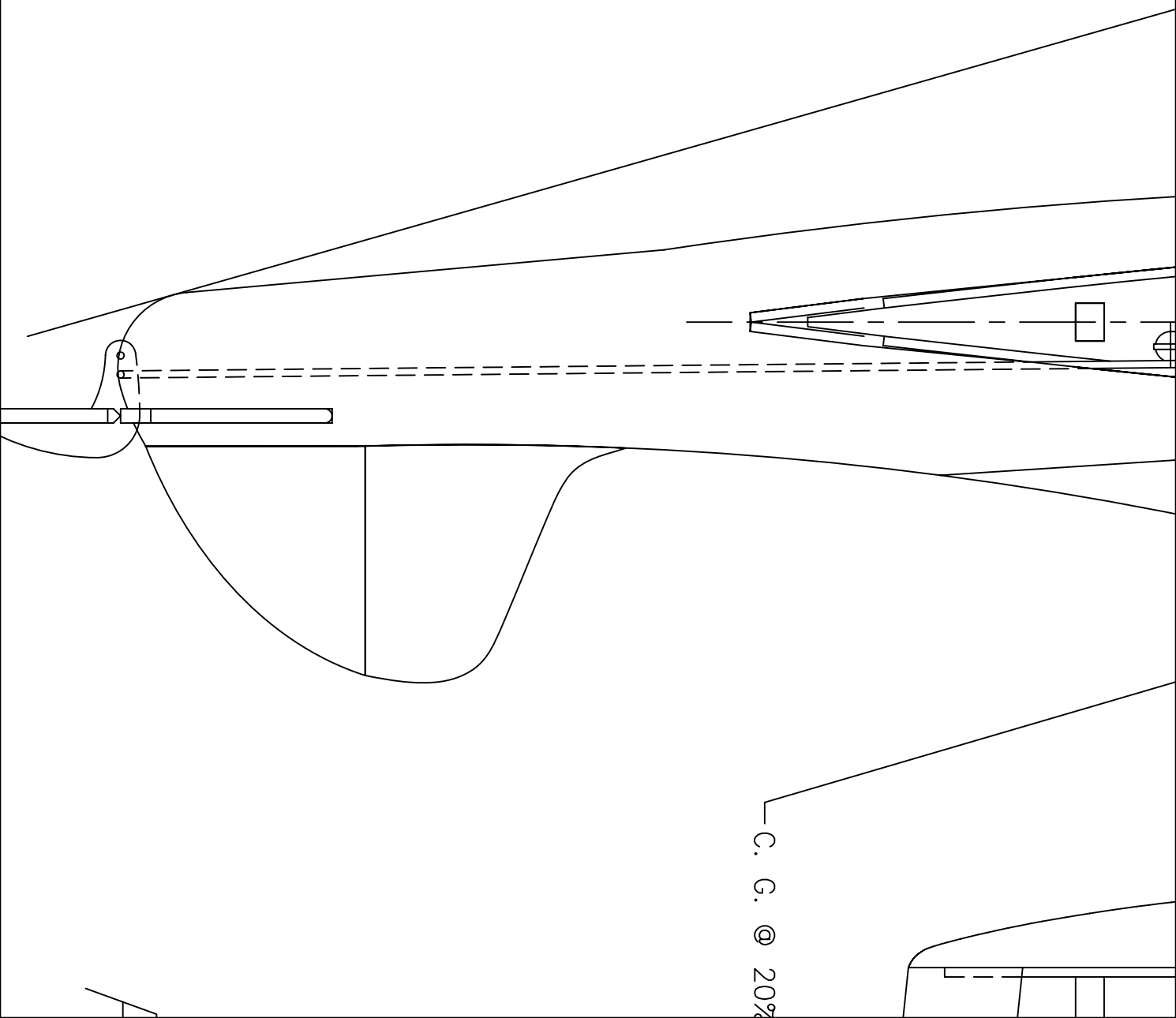

C. G. @ 20%

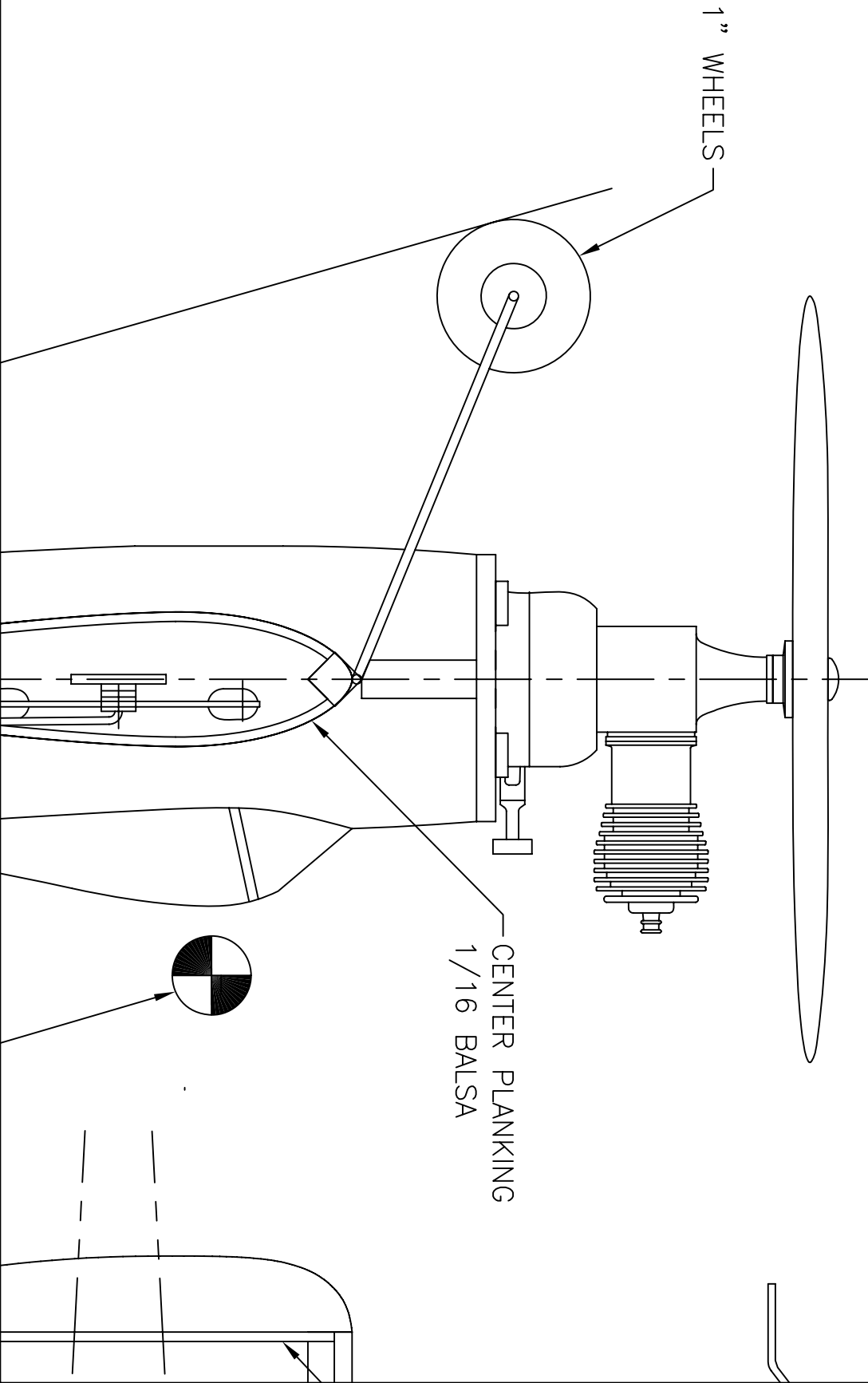

p1, row1, col4

RIBS 1/16 BALSA
2 EACH REQ'D.

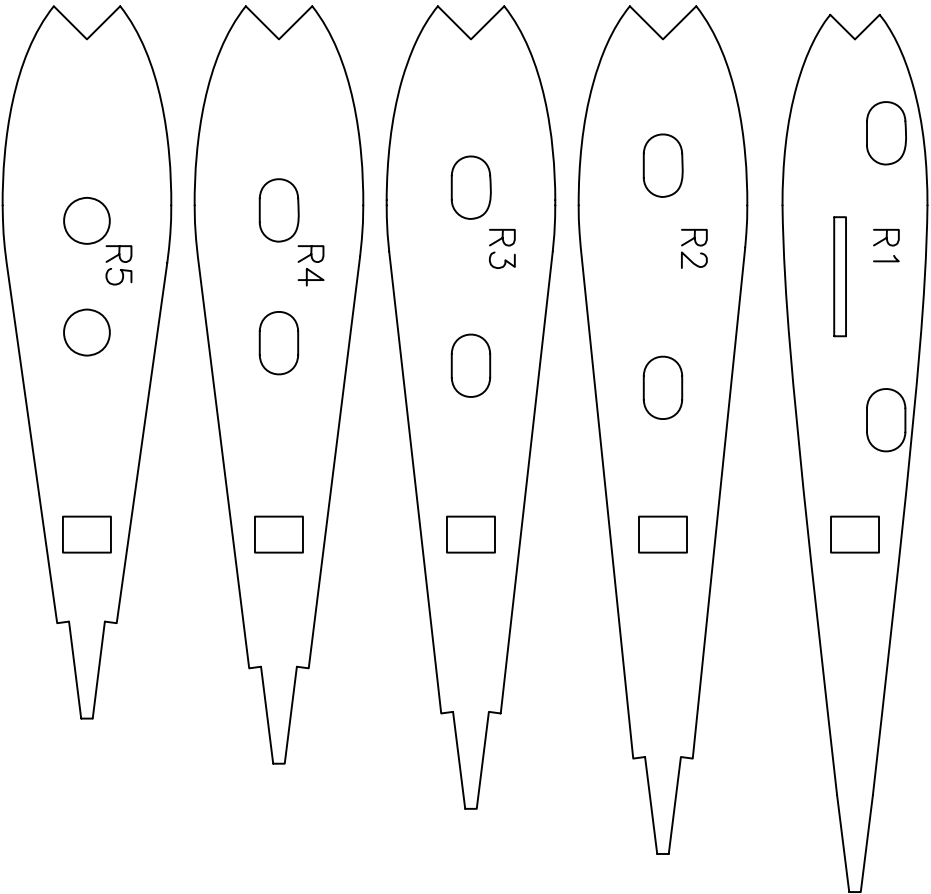

MOTOR MOUNT
1/8 PLY

BELLCRANK MOUNT
1/16 PLY

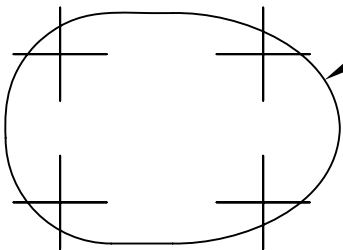

VERTICAL STA

DIMENSIONS IN INCHES

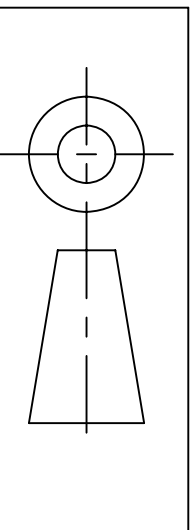

BABY RIN
1/2 A
21" SPAN
STERLING

Work,
5133 Jd

S M.A.C.

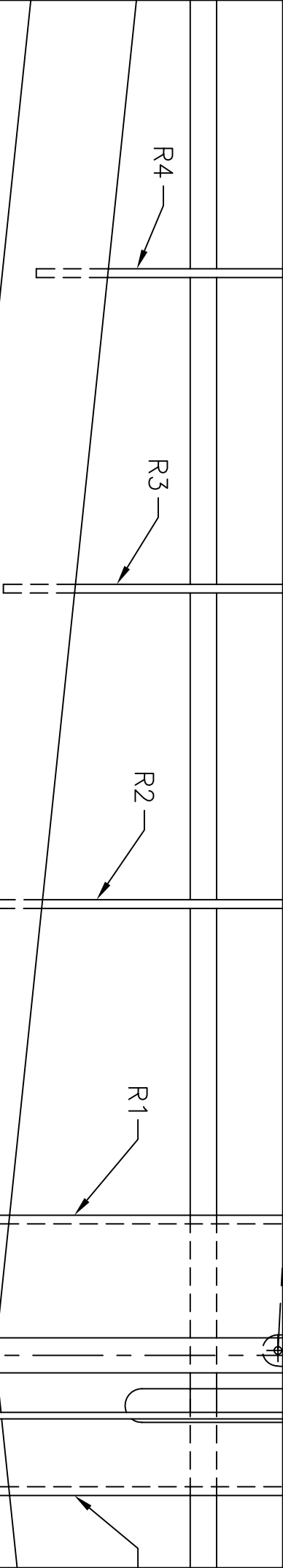

BASED ON
MATT KANIA'S
PRINGMASTER

p1, row2, col2

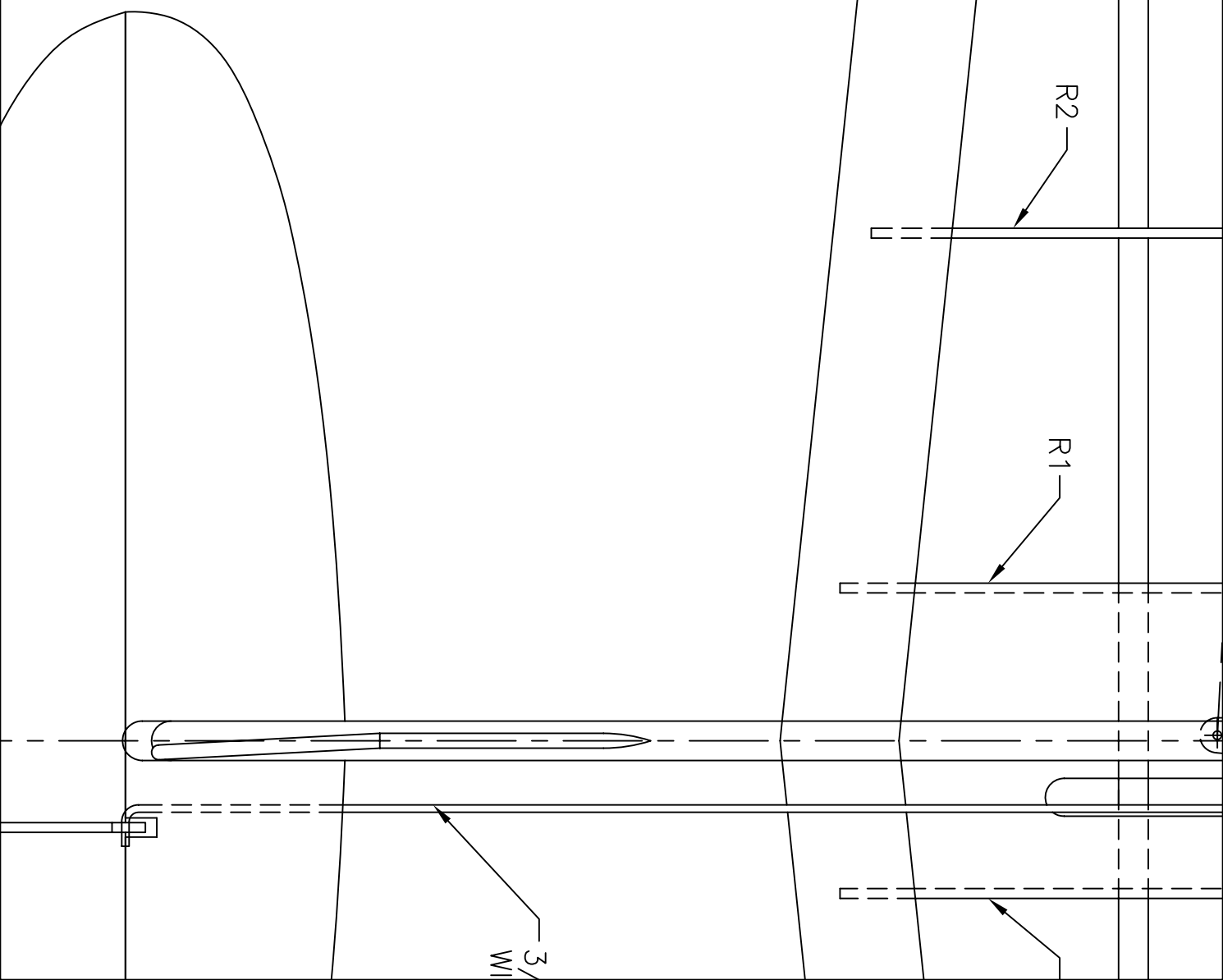

p1, row2, col3

R5

1/16 MUSIC WIRE

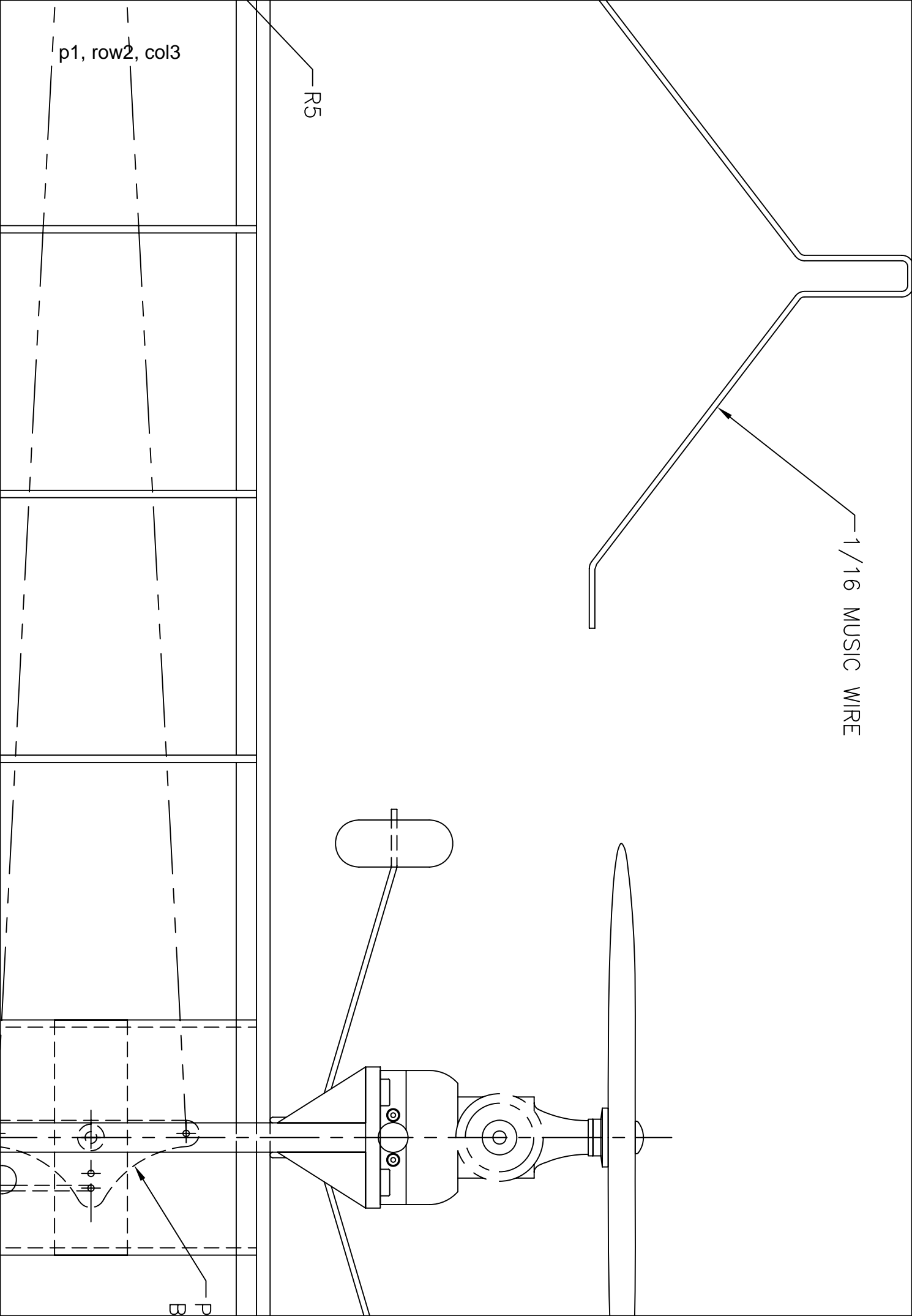

p1, row2, col4



CONTROL HORN
1/16 PLY

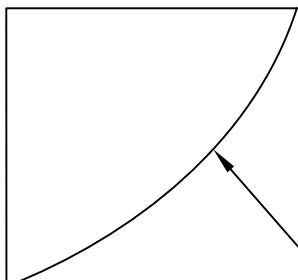
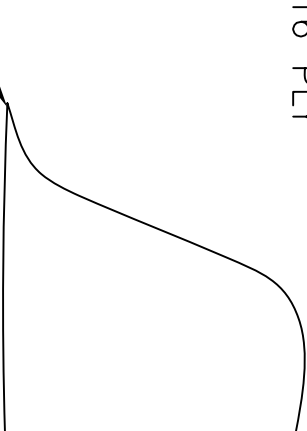
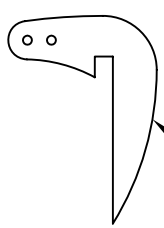

RUDDER 3/32 BALSA

BILIZER 3/32 BALSA

NGMASTER

95 SQ. IN.

KIT S13

© 2008 LOCK, STOCK, & BARREL
ALL RIGHTS RESERVED

Lock, & Barrel

son Dr., Monree, IL 60449 Ph. 708-534-1082

REV	DATE	BY	REVISION	ANGLE ± 0.5 DEGREES	LBS KGS
TOLERANCE UNLESS SPECIFIED	0.0 ± .03	0.00 ± .005	0.000 ± .001	.	.

THIS DRAWING AND ALL INFORMATION THEREOF IS THE PROPERTY OF LOCK, STOCK, & BARREL. IT IS LOANED FOR THE SOLE PURPOSE OF DISCUSSION OR MAINTENANCE OF EQUIPMENT OR DESIGNS SUPPLIED BY LOCK, STOCK, & BARREL. REPRODUCTION OF THIS DRAWING OR DISCLOSURE TO ANY OTHER PARTY IS NOT AUTHORIZED. ALL RIGHTS RESERVED

CHECKED	PLANS	DWG NO BRM	REV. 0
APPROVED			
DRAWN J.D.K.			
DATE 23 MAR 02			
SCALE FULL			SHEET 1 OF 1

R1

R2

R3

R4

SPAR 3/16 X 1/4
BALSA

TRAILING EDGE 4 PCS.
1/16 X 3/4 BALSA

64 MUSIC
RE

p1, row3, col2

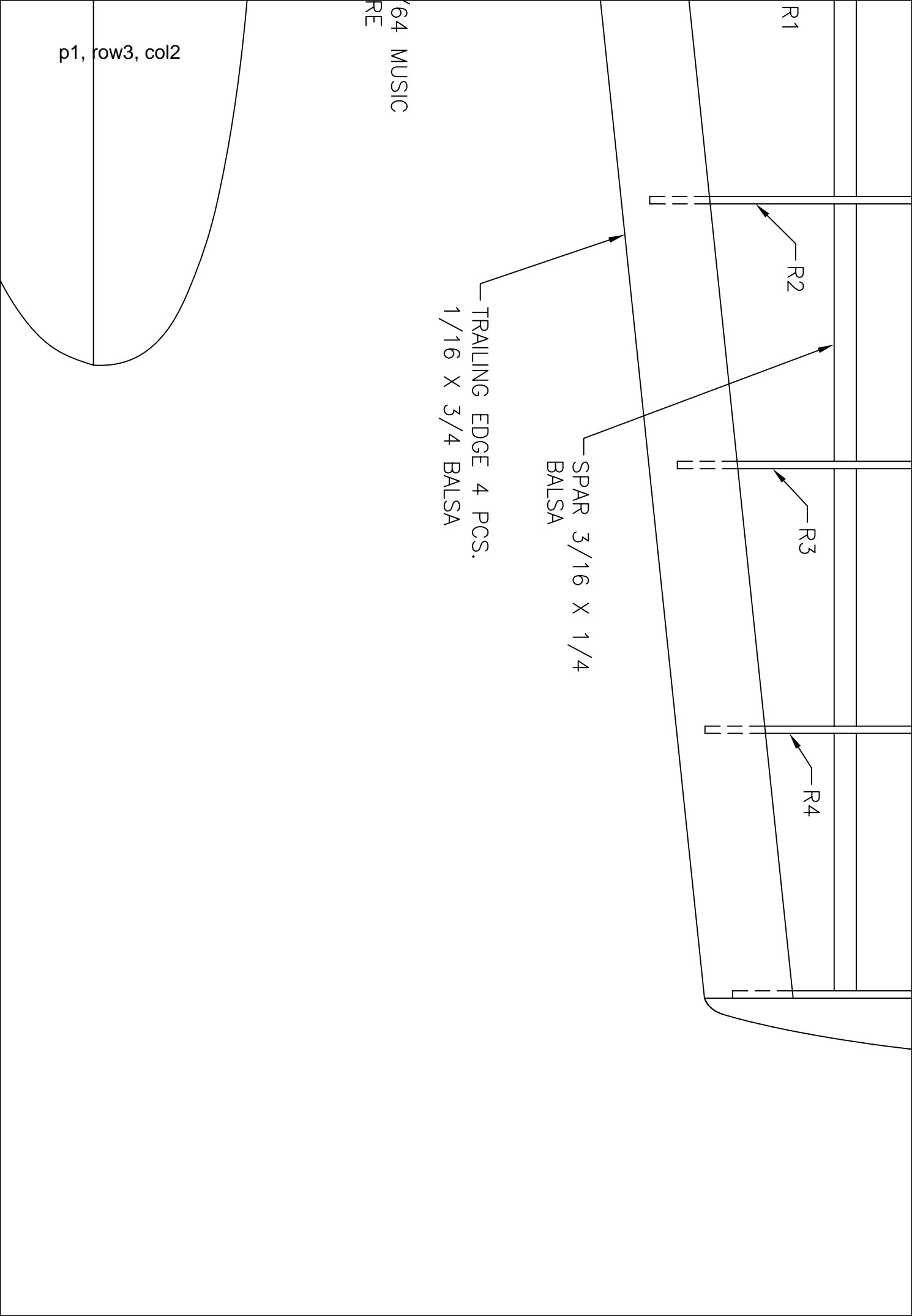

WARNING - DANGER!
DO NOT FLY NEAR POWER LINES!
INSTANT DEATH CAN RESULT FROM
CONTACT WITH, OR PROXIMITY TO
ELECTRIC POWER LINES.

LEADING EDGE
1/4" SQ. Balsa

R5

PERFECT 1/2 A
ELLGRANK
p1, row3, col

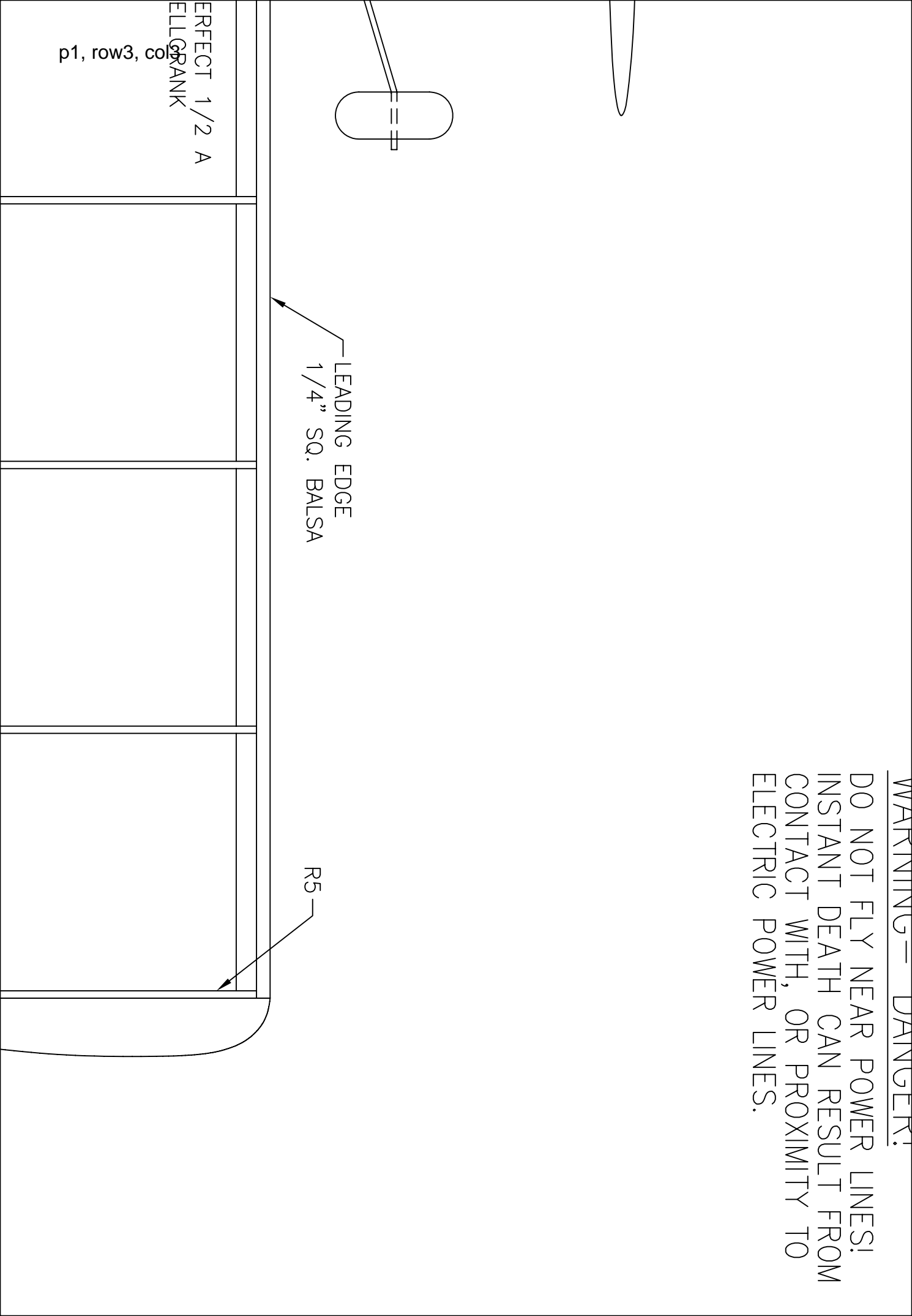

p1, row3, col4

WARNING DANSCERI

p1, row4, col1

p1, row4, col2

p1, row4, col3

p1, row4, col4