

COMPLETED MODEL
(With left side removed for clarity)

EAGLE 63

8/C SPORT TRAINER
FOR 3 or 4 CHANNEL RADIO and .29 to .49 ENGINES
SPAN 42-5/8" LENGTH 45"
AREA 715 SQ. IN. WEIGHT 78 oz.

DESIGNED BY CARL GOLDBERG
TECHNICAL ASSISTANCE BUILDING & FLYING BY JIM PETRZELKA
DRAWN BY WARREN HROMBERGER AND RALPH MOYSEWITZ
CONSTRUCTION PHOTOS BY ROGER CHAMBERY



THE EAGLE IS MADE FROM FOUR KINDS OF WOOD: Balsa, Bass, Birch, and various plywoods. Each of these woods has its own characteristic end grain pattern (as viewed from the end) which has been drawn on the plans. You can easily use these patterns to identify what kind of wood is shown for a part if you are in doubt.

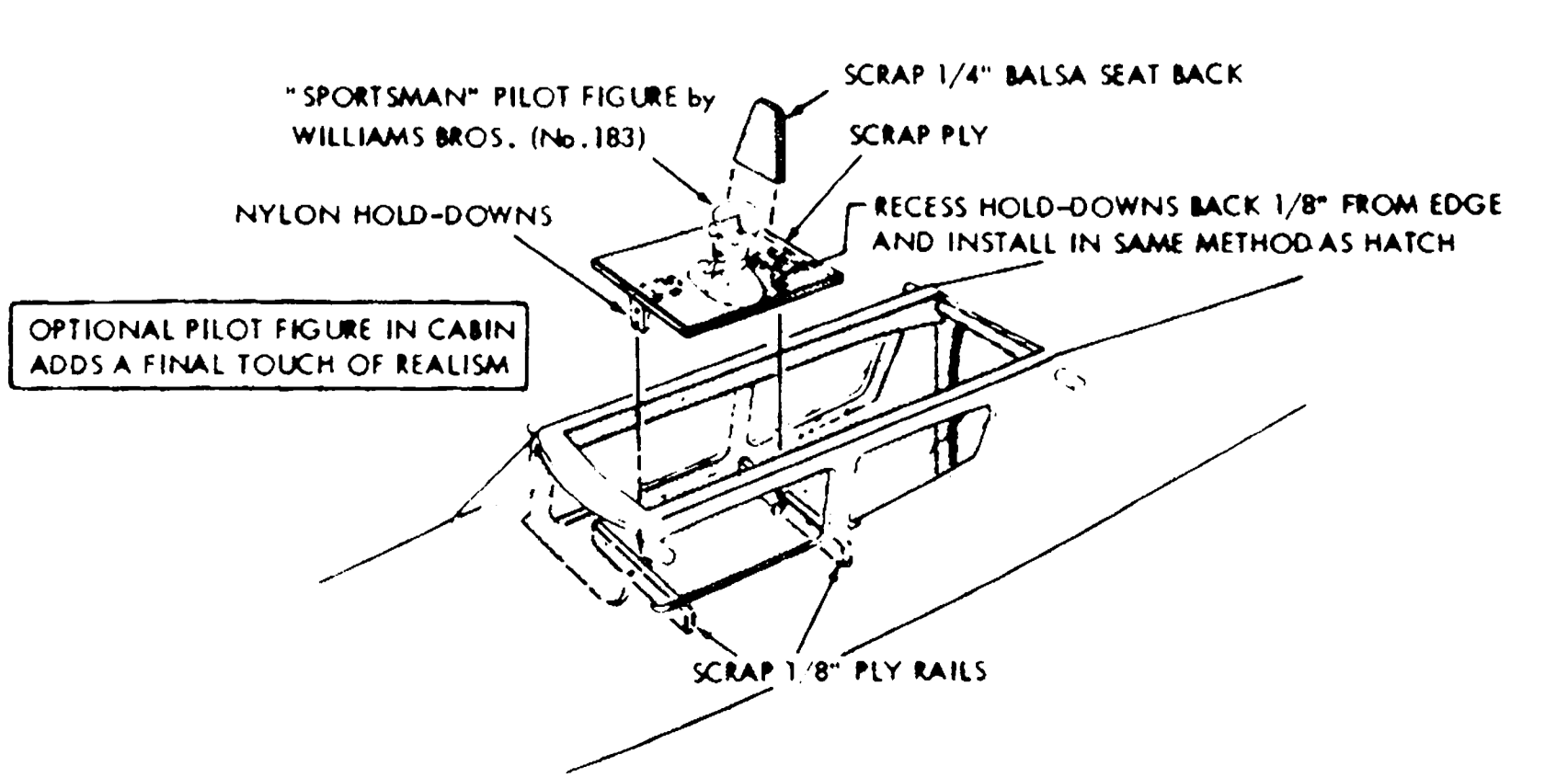
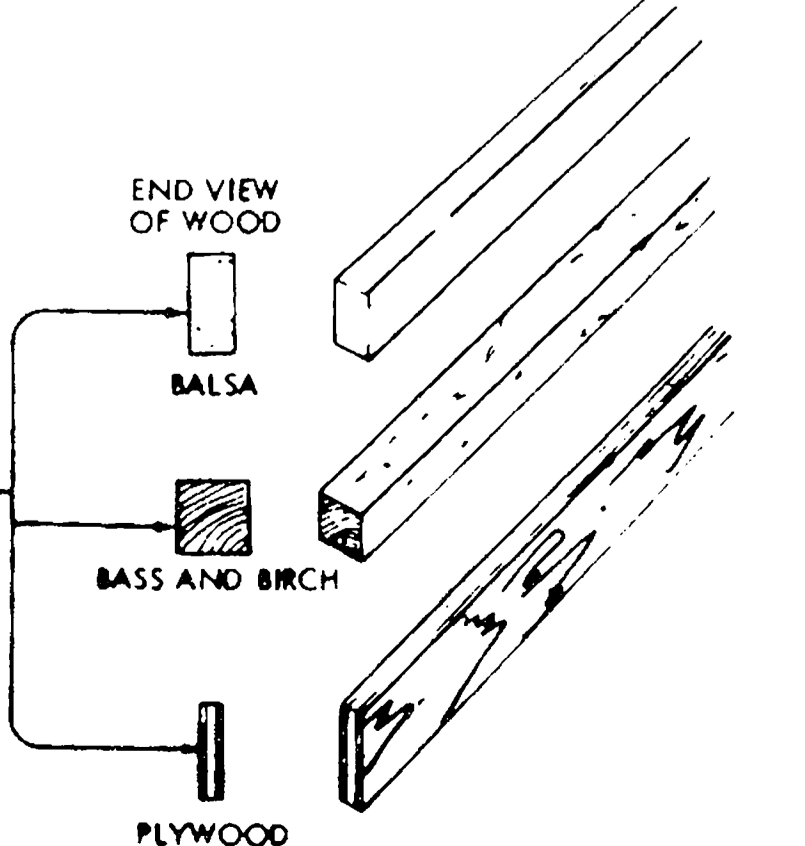

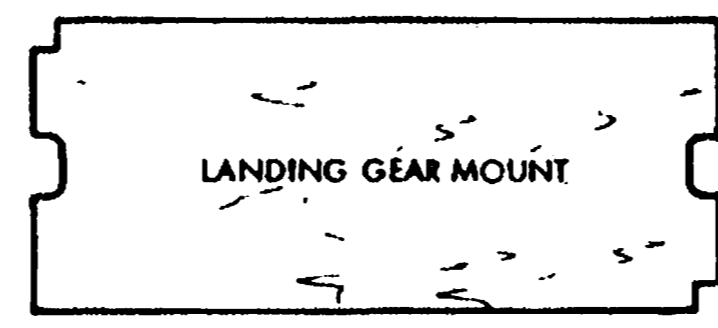
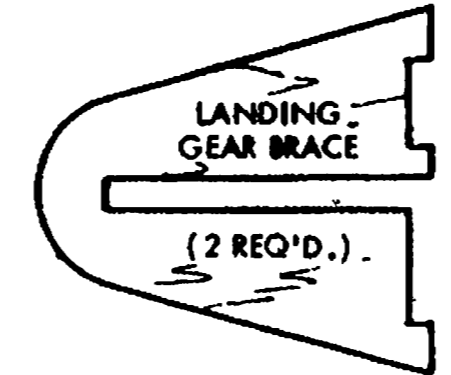
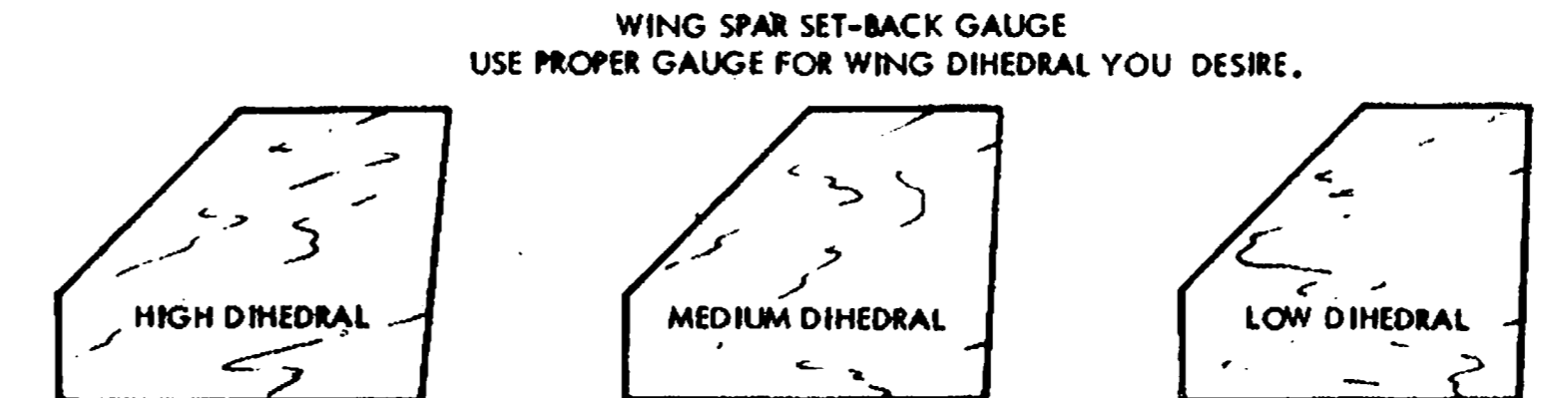
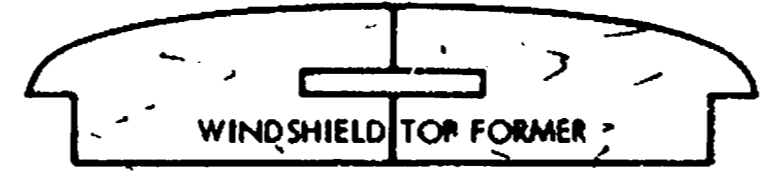
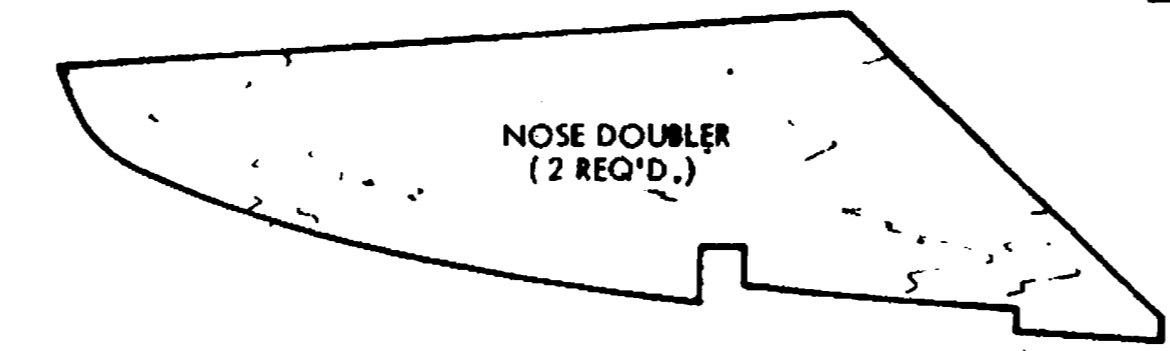
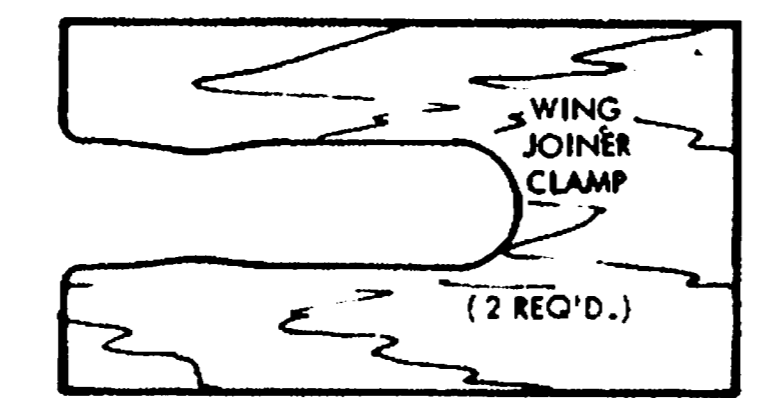
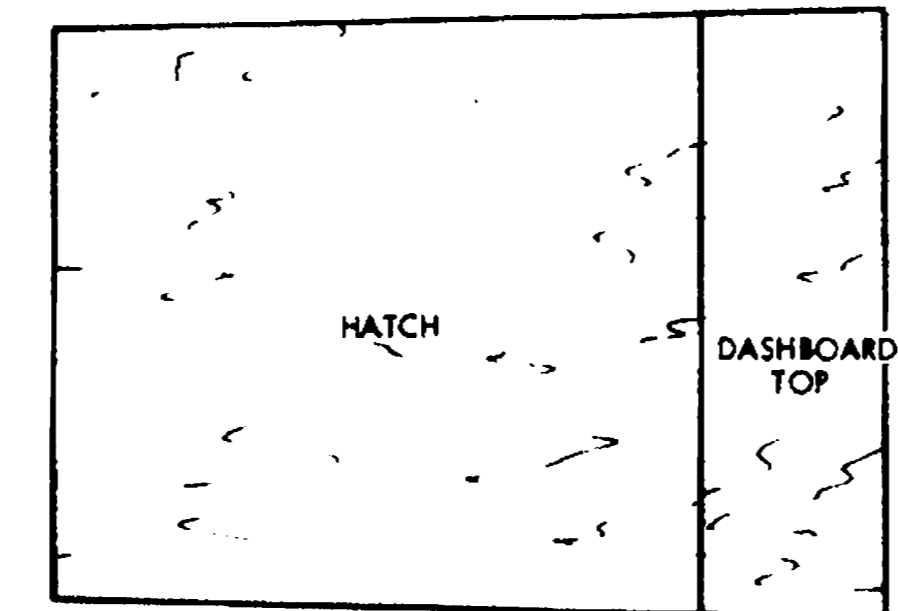
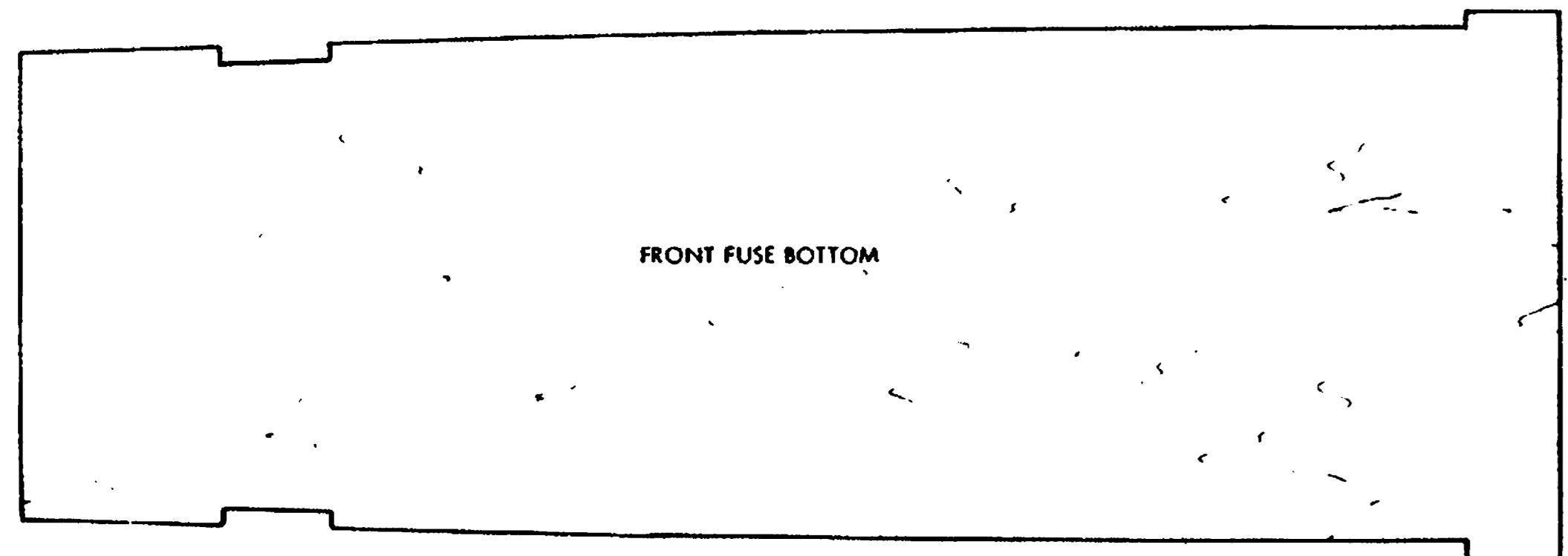
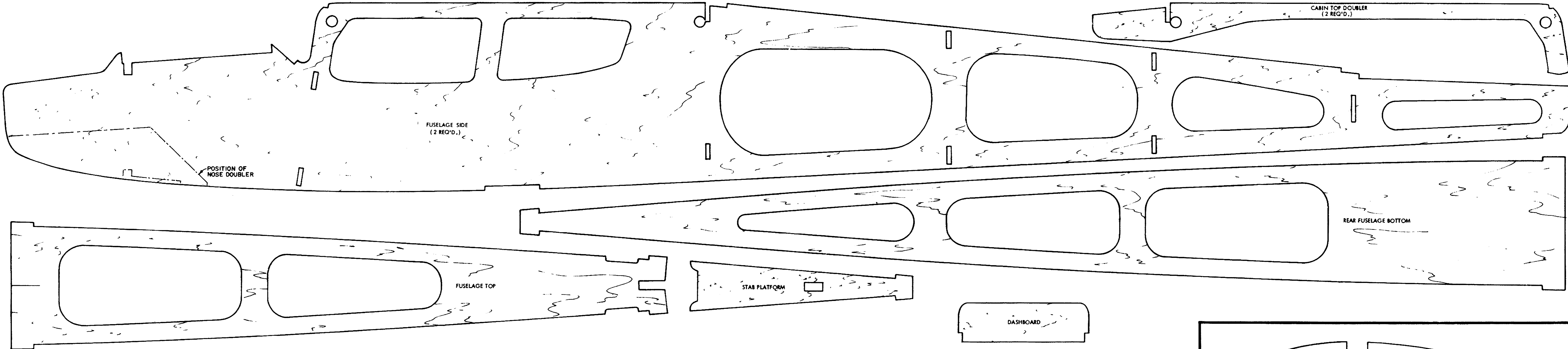

EAGLE 63 (SHEET 2 OF 2)

ALL PARTS TO BE MADE FROM 1/8" LITE PLY, UNLESS OTHERWISE SPECIFIED*.

IF DUPLICATES OF A PART ARE REQUIRED, THE QUANTITY IS SPECIFIED IN PARENTHESIS.

WHEN CUTTING PARTS NOTE GRAIN DIRECTION.

© PCM ALL COMMERCIAL RIGHTS RESERVED

